

Lever-type Dial Test Indicators



TESA IP65 Electronic Dial Test Indicators

Provides the advantages of a mechanical test indicator with a digital reading.



- Inductive patented measuring system.
- Analogue and digital indication.
- Digital step of 0,01/0,001 mm.
- Selectable scale division: 10, 20, 50 μm /1, 2, 5 μm .
- Cutting oils and liquid coolant resistant (IP65).
- Metric/inch conversion.
- RS232 data output combined with external power supply.
- Displayed measuring modes (NOR/MIN/MAX/MAX-MIN).
- Automatic shut-down.
- Compatible with all TESAST accessories.

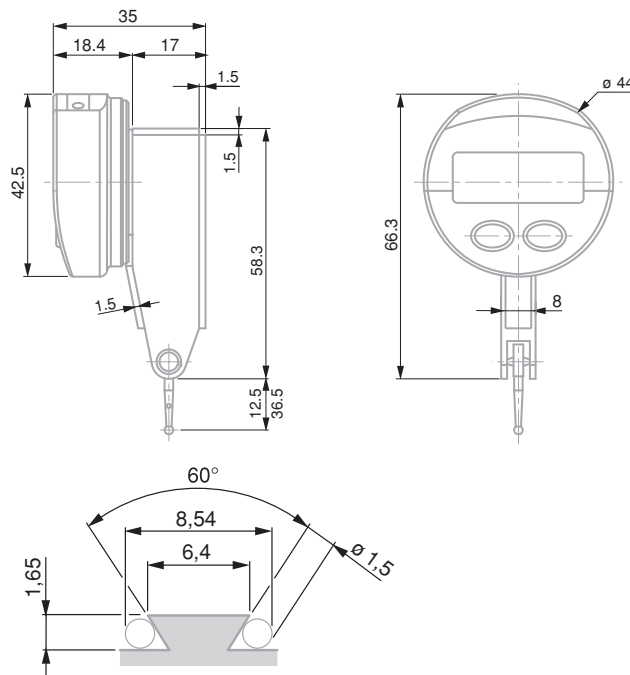

No					
	mm	mm	in	N ($\pm 15\%$)	Stem length, mm
01830001	0,8	0,01/0,001	0.0005/0.00005	0,13	12,5
01830002	0,5	0,01/0,001	0.0005/0.00005	0,07	36,5

OPTIONAL ACCESSORIES:

- 01961000 Lithium battery, 3V, CR2032
- 04761060 RS 232 cable with external power supply

Compatible with all TESAST measuring inserts and accessories

- LCD, 5 digits + unit
- Resolution to 0,01/0,001 mm; 0.0005/0.00005 in
- Display digit height 6 mm
- Max. perm. errors: $f_e = 10 \mu\text{m}$; $f_{ges} = 13 \mu\text{m}$; Pre-span = 0,05 mm
- Repeatability: $f_w = 1 \mu\text{m}$
- Hysteresis: $f_h = 3 \mu\text{m}$
- L = 12,5 mm; max. 0,05 m/s; L = 36,5 mm; max. 0,15 m/s
- Number of measurements per second: 9
- Zero-setting
- RS232
- 3 V lithium battery, type CR2032
- Battery life > 4000 hours
- Operating temperature range: +5°C to +40°C
- Degree of protection: IP65 (IEC 529)
- EN 61326-1
- 73 g (L = 12,5 mm); 75 g (L = 36,5 mm)
- Supplied in a plastic case with:
1 Insert with a 2 mm dia. (No. 01860202)
1 Wrench (No. 01860307)
1 Mounting rod 8 mm dia. (No. 01840105)
- Identification number
- Declaration of conformity





DIN 2270
NFE 11-053

TESATAST DIAL TEST INDICATORS

These lever-type dial test indicators are especially intended for use on the shop floor or in the inspection room – Ideally suited for comparative measurements on a surface plate, for instance – Determine form, shape and position deviations as well as axial and runout errors.

- Bidirectional measuring with automatic reversal inside the movement.
- Continuous clockwise pointer rotation providing error-free reading.
- Insensitive to magnetic fields.
- Jewelled movement with 7 rubies.
- Ball-bearing lever system. Measuring insert swivelling through to 240°.
- Very low measuring force.
- Exceptionally robust with full-metal construction.

Standard model

Well proven over thousands of times. The dial face is parallel to the axis of the measuring insert.

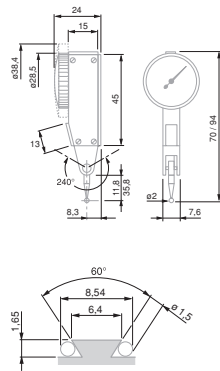

Perpendicular model

Lever test indicator with dial face mounted at right angle to the axis of the measuring insert.

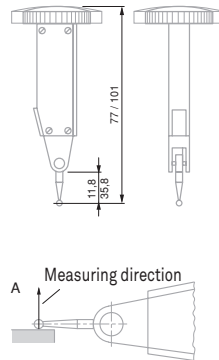

Lateral Model

Dial test indicator with dial face mounted parallel to the axis of the measuring insert but on the flat side of the dial housing.

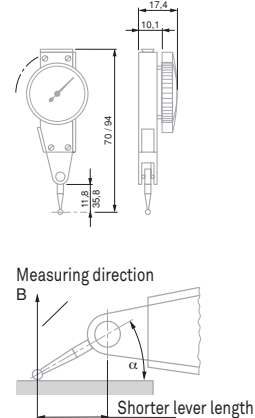

Note on the use of TESATAST dial test indicators

With the measuring insert lying parallel to the workpiece surface (Fig. A), these indicators give true reading due to the amplification factor to 1:1.

In another measuring position (angle α in Fig. B), the effective lever length changes so that the read value needs to be corrected. With respect to this, also refer to the instruction manual.

Permissible limits of a metrological characteristic (MPE/MPL)

		0,02 mm	0,01 mm	0,002 mm
	Deviation span, f_e	27 μm	10 μm	2 μm
	Deviation span within the local measuring span, f_t	0,20 mm 0,10 mm 0,02 mm	12 μm 5 μm	1 μm
	Total deviation span, f_{ges}	31 μm	13 μm	3,5 μm
	Repeatability limit, f_w	4 μm	3 μm	1 μm
	Max. hysteresis, f_u	4 μm	3 μm	1,5 μm
	Measuring force with insert:			
	Length	12,53 mm	0,15 N	0,15 N
		36,53 mm	0,06 N	0,06 N





TESATAST Standard Models

No					
	mm	mm	Ø, mm		Insert, mm
01810005	0,8	0,01	28	0 ÷ 0,4 ÷ 0	12,53
01810006	0,8	0,01	38	0 ÷ 0,4 ÷ 0	12,53
01810007	0,5	0,01	28	0 ÷ 0,25 ÷ 0	36,53
01810008	0,5	0,01	38	0 ÷ 0,25 ÷ 0	36,53
01810009	0,2	0,002	28	0 ÷ 100 ÷ 0	12,53
01810010	0,2	0,002	38	0 ÷ 100 ÷ 0	12,53
S18001695	0,2	0,001	38	0 ÷ 100 ÷ 0	12,53



SWISSTAST Standard Models

No					
	mm	mm	Ø, mm		Insert, mm
01811000	0,8	0,01	28	0 ÷ 0,4 ÷ 0	12,53
01811001	0,2	0,002	38	0 ÷ 100 ÷ 0	12,53

Same technical data as standard models, but equipped with a 2 mm dia. ruby ball tip No. 01860302.



TESATAST Perpendicular Models

No					
	mm	mm	Ø, mm		Insert, mm
01810204	0,8	0,01	28	0 ÷ 0,4 ÷ 0	12,53
01810205	0,5	0,01	28	0 ÷ 0,25 ÷ 0	36,53
01810304	0,2	0,002	38	0 ÷ 100 ÷ 0	12,53

- DIN 2270
NF E 11-053
- Rotating dial
- Very low measuring force, see table.
- Movement with patented shock proof system
- Lever system with friction drive to prevent overload
- Accuracy: see table.
- Supplied in a plastic case together with:
1 Insert with a 2 mm dia.
1 Wrench (No. 01860307)
1 Mounting rod 8 mm dia. (No. 01840105)
- Identification number
- Declaration of conformity

TESATAST Lateral Models



No					
	mm	mm	∅, mm		Insert, mm
01810011	0,8	0,01	28	0 ÷ 0.4 ÷ 0	12,53
01810012	2	0,02	38	0 ÷ 1.0 ÷ 0	36,53
01810013	0,2	0,002	28	0 ÷ 100 ÷ 0	12,53



M1,4 coupling thread



Ball tip made of carbide or ruby

TESATAST Measuring Inserts

No			
	Ball tip, mm	Ball tip material	mm
01860201	1	Carbide	12,53
01860202	2	Carbide	12,53
01860203	3	Carbide	12,53
01860211	1	Carbide	36,53
01860212	2	Carbide	36,53
01860213	3	Carbide	36,53
01860301	1	Ruby	12,53
01860302	2	Ruby	12,53
01860303	3	Ruby	12,53
01860304	1	Ruby	36,53
01860305	2	Ruby	36,53
01860307	Wrench for inserts		

Note:

The original measuring insert mounted on every TESATAST as well as any other insert of the same nominal length but with a different ball tip diameter are fully interchangeable.

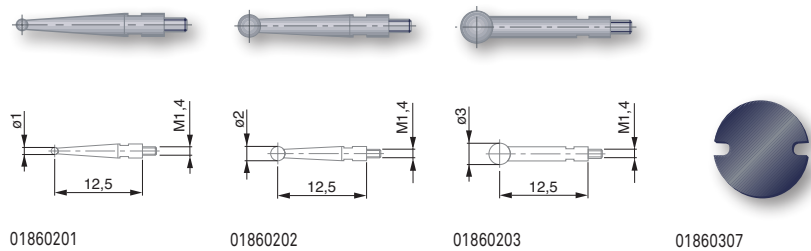

DIN 2270
NFE 11-053



Technical data: see description for each product



Plastic case



Identification number



Declaration of conformity

Indicator Sets with Small Support

No	
01630003	Indicator set with small support
COMPOSITION OF THE SETS:	
01810005	TESATAST standard model
01810010	TESATAST standard model
01860203	Carbide measuring insert
01840104	Mounting rod
01840105	Mounting rod
01860307	Wrench for inserts
01639007	Magnetic support INTERAPID UJ15, dovetail clamp and ∅ 8 mm cylindrical clamping





Accessories for TESATAST

Clamp

No	=		mm
01860401			Ø 5,6 / Ø 9,5



01860401

Mounting Rods

No	=		mm
01840404			Ø 8 x 25
01840405			Ø 8 x 90
01840406			Ø 8 x 25 (Ø 8 for clamping bore)
01840501			Ø 8 x 25 (Ø 4 for clamping point)
01840407			Ø 8 x 125



01840501



01840404



01840405



01840406



01840407

Fixing Shank

No	=		mm
01840104			Ø 4
01840105			Ø 8
01840202			Ø 8 x 80 (Ø 5,6 for the tenon)
01860008			Ø 6

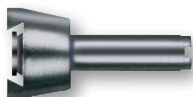

01840104

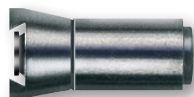

01840105



01840202

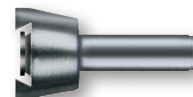

01860008



INTERAPID 312 LEVER DIAL TEST INDICATORS

INTERAPID 312 Dial Test Indicators very large measuring span – Ideal for inspecting all significant size variations, e.g. on the surface plate – Measures position, form and shape errors.



- Safe reading thanks to secondary pointer totalling the number of revolutions made by the main pointer.
- Bidirectional measuring with automatic reversal within the movement.
- Pointer rotation direction is always constant due to automatic reversal effect.
- Jewelled movement with rubies.
- Ball-bearing lever system. Measuring insert swivelling through 210°.
- Particularly robust due to full-metal construction.
- Monobloc housing with mounting through dovetail clamping and a Ø 4 mm swivelling shank.

Stylus insert with angular position of 12°

All models INTERAPID 312 are designed to give a true reading when the angle between the stylus and the workpiece surface is 12° (Fig. A). In any other measuring position, including parallel position of the stylus against the workpiece surface, measured readings have to be corrected accordingly (Fig. B). Please consult the instruction manual on this subject.

Standard Model

Time-tested dial test indicator. The dial face is mounted parallel to the axis of the insert.

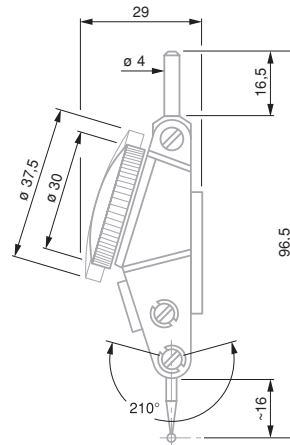

Perpendicular model

Dial test indicator with dial face mounted at right angle to the axis of the insert.

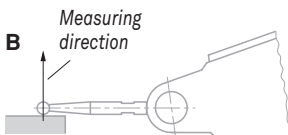
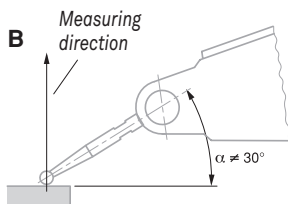
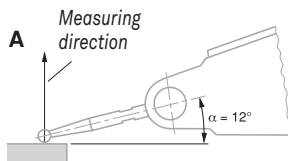
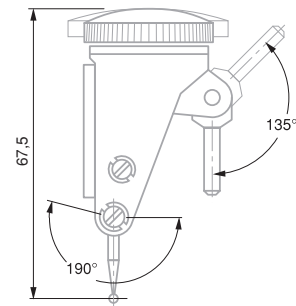

Permissible limits of a metrological characteristic (MPE/MPL)

	0,01 mm		0,002 mm	
	Pointer revolution		Pointer revolution	
Deviation range over partial measuring range, f_e	1	2	1	2
Total deviation range, f_{ges}	10 μ m	20 μ m	4 μ m	8 μ m
Repeatability limit, f_w	3 μ m		1 μ m	
Max. hysteresis, f_u	3 μ m		2 μ m	
Measuring force	0,12 N		0,25 N	





INTERRAPID 312 Standard Models

No	mm	mm	∅, mm		Insert, mm
074111366	1,6	0,01	37,5	0 ÷ 40 ÷ 0	16,5
074111367	1,6	0,01	30	0 ÷ 40 ÷ 0	16,5
074111368	0,4	0,002	37,5	0 ÷ 10 ÷ 0	15,2
074111369	0,4	0,002	30	0 ÷ 10 ÷ 0	15,2

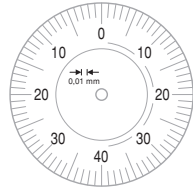

074111366



074111367

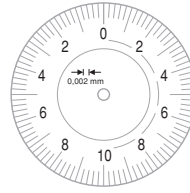

074111368

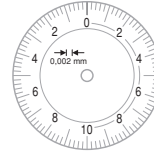

074111369



INTERRAPID 312 Perpendicular Models

No	mm	mm	∅, mm		Insert, mm
074111375	1,6	0,01	37,5	0 ÷ 40 ÷ 0	16,5
074111376	1,6	0,01	30	0 ÷ 40 ÷ 0	16,5

Dial Test Indicator Sets, Complete with Accessories – INTERRAPID 312 Standard Models

Each full set consists of:



No	=
	INTERRAPID 312 lever test indicators as listed in the table below:
074106331	Rectangular mounting attachment
074108942	Reducing sleeve, metric
074106026	Swivel holder, metric
074111474	Case for measuring inserts
01860307	Wrench for measuring inserts

No	074111366	074111367	074111368	074111369	074106331	074108942	074106026	074111474	01860307
074111502	•			•	•	•	•	•	•
074111503		•		•	•	•	•	•	•
074111504			•	•	•	•	•	•	•
074111505				•	•	•	•	•	•



Rotating dial

Very low measuring force: (see table for tolerance limits)

Lever system with friction drive to prevent overload

Accuracy: see table for tolerance limits

Supplied in a plastic case with:
1 with a ∅ 2 mm insert in hardened steel,
1 stylus key
No. 01860307

Declaration of conformity



Technical data: see description for each product

Plastic case

Declaration of conformity



M1,7 coupling thread

Ball tips in hardened steel or tungsten carbide

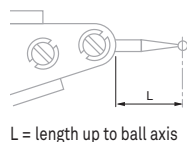

Measuring Inserts

No	mm	Ball tip, mm	Ball tip material	L mm
074107893	0,01	2	Steel	16,5
074107895	0,01	1,5	Steel	16,5
074107897	0,01	0,8	Steel	16,5
074110481	0,002	2	Steel	15,2
074110492	0,002	1,5	Steel	15,2
074110493	0,002	0,8	Steel	15,2
074105993	0,01	2	Carbide	16,5
074105994	0,01	1,5	Carbide	16,5
074105995	0,01	0,8	Carbide	16,5
074106358	*	2	Carbide	36,6
074106360	*	0,8	Carbide	36,6
074110482	0,002	2	Carbide	15,2
074110491	0,002	1,5	Carbide	15,2
074110507	0,002	0,8	Carbide	15,2

* The length of the insert used changes the amplification factor of the lever system. The values read off must therefore be doubled.



Accessories for INTERAPID 312

Clamping Attachment

No	=	mm
074108603	Double attachment with clamping point and dovetail	∅ 4

Holders

No	=	mm
074106026	Swivel holder with clamping points and dovetail	∅ 8 x 133 (∅ 4 for clamping point)

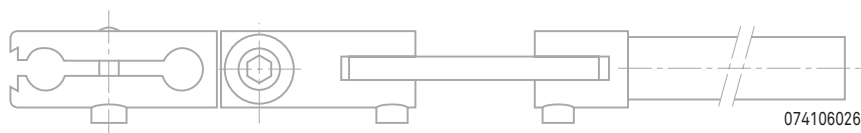

Clamping Attachment

No	=	mm
074106331	Rectangular clamping attachment complete	∅ 8 / ∅ 4

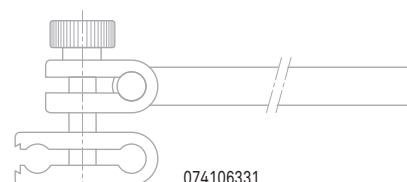

Reducing Sleeve

No	=	mm
074108942	Reducing sleeve	∅ 8 / ∅ 4

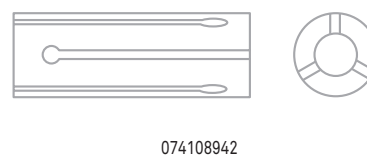

COMPAC DIAL TEST INDICATORS

Essential for the workshop, but also in the inspection room or measuring laboratory – Ideal for comparative measurement on a surface plate – Detect form and position errors – Measure axial and radial runouts, especially.

Technical Features

- Long measuring travel, up to 3 mm.
- Bidirectional measuring, without reversing lever.
- Same rotation direction of pointers in the two measuring directions (clockwise pointer direction).
- Swivelling probe through 180°.
- Main pivot on self-aligning angular bearings, dimensioned oversize.
- Dovetail mounting machined in the indicator housing.
- Dull chrome-plated bezel and housing.
- Rotating dial.
- Insensitive to magnetic fields generated in mechanical workshops.

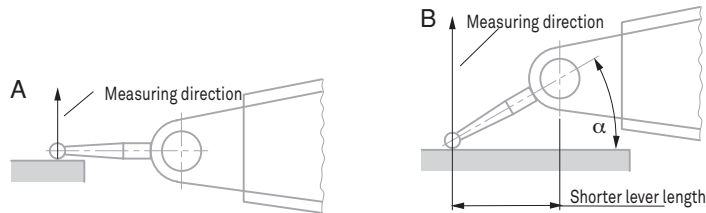

Note for use of COMPAC dial test indicators

With the measuring insert lying parallel to the workpiece surface (Fig. A), these dial test indicators give true reading due to the amplification factor of 1:1. In any other measuring position (angle α in Fig. B), the effective lever length changes. The values indicated need be corrected. In this connection, please consult the instruction manual.

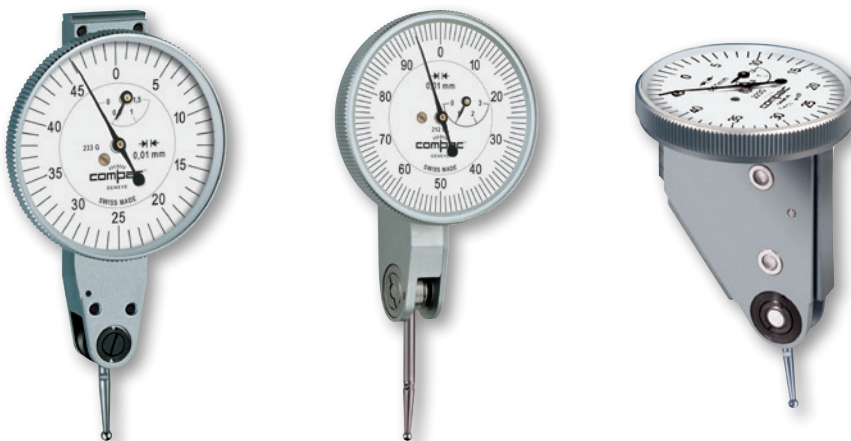

COMPAC Series 210 – Standard Models, Metric

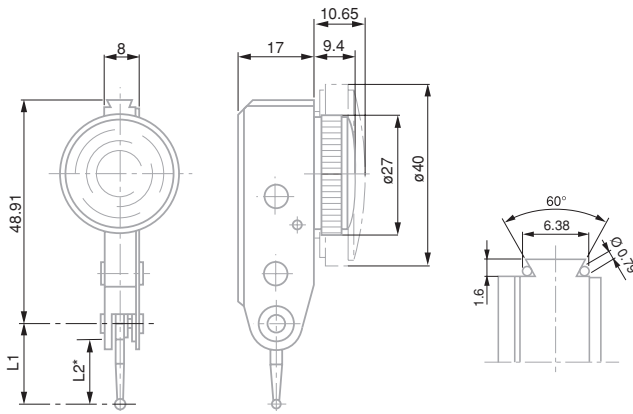

L2; see table of inserts for COMPAC lever-type test indicators

- DIN 2270 and factory standard
- Rotating dial
- Contact points with tungsten carbide ball tips
- Friction lever system to prevent overload
- Supplied in a plastic case, including:
1 contact point, 2 mm dia.
1 rigid stem 8 mm dia., L = 15 mm, No. 01840107
1 rigid stem 4 mm dia., L = 15 mm, No. 01840109 (except for series 220).
- Serial number
- Inspection report with a declaration of conformity

No										
	Total travel, mm	μm	μm	μm	μm	Travel/revolution, mm	\varnothing , mm	N	Insert L1, mm	
213	1,5	0,01	13	3	3	0,5	27	0 ÷ 25 ÷ 50	≤ 0,35	18
213G	1,5	0,01	13	3	3	0,5	40	0 ÷ 25 ÷ 50	≤ 0,35	18
212L	3	0,01	26	3	6	1	27	0 ÷ 50 ÷ 100	≤ 0,20	36
212GL	3	0,01	26	3	6	1	40	0 ÷ 50 ÷ 100	≤ 0,20	36
215	0,6	0,002	13	1,5	2,5	0,1	27	0 ÷ 5 ÷ 10	≤ 0,30	18
215G	0,6	0,002	13	1,5	2,5	0,1	40	0 ÷ 5 ÷ 10	≤ 0,30	18
215GL	1,2	0,002	26	1,5	5	0,2	40	0 ÷ 10 ÷ 20	≤ 0,20	36
216G	0,6	0,001	13	1,5	2,5	0,1	40	0 ÷ 5 ÷ 10	≤ 0,30	18

COMPAC Series 220 – Perpendicular Models, Metric

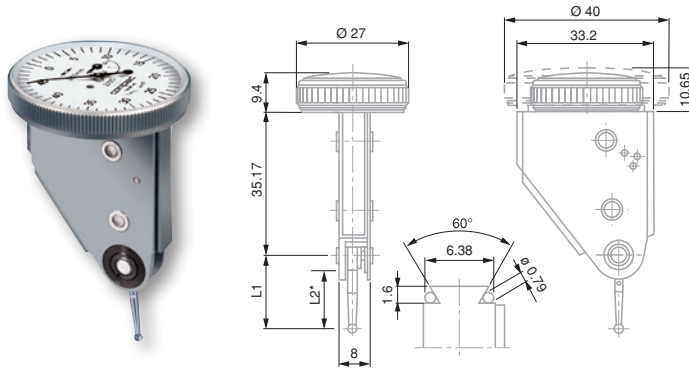

*L2 see table of inserts for COMPAC lever-type test indicators

No										
	Total travel, mm	μm	μm	μm	μm	Travel/revolution, mm	\varnothing , mm	N	Insert L1, mm	
223	1,5	0,01	13	3	3	0,5	27	0 ÷ 25 ÷ 50	≤ 0,35	18
223G	1,5	0,01	13	3	3	0,5	40	0 ÷ 25 ÷ 50	≤ 0,35	18
222L	3	0,01	26	3	6	1	27	0 ÷ 50 ÷ 100	≤ 0,20	36
222GL	3	0,01	26	3	6	1	40	0 ÷ 50 ÷ 100	≤ 0,20	36
225	0,6	0,002	13	1,5	2,5	0,1	27	0 ÷ 5 ÷ 10	≤ 0,30	18
225G	0,6	0,002	13	1,5	2,5	0,1	40	0 ÷ 5 ÷ 10	≤ 0,30	18



COMPAC 230 Parallel Models

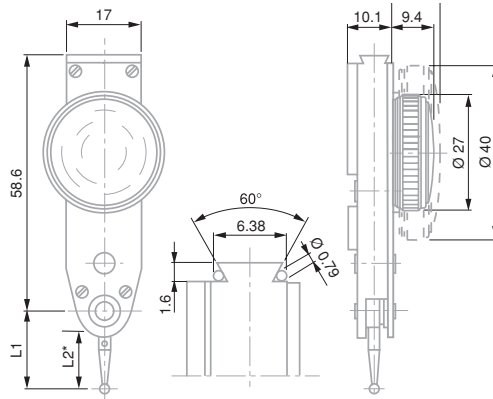

* L1 see table of inserts for COMPAC lever-type indicators

No	Total travel, mm	mm	µm	µm	µm	Travel/revolution, mm	Ø, mm	N	Insert L1, mm
233	1,5	0,01	13	3	3	0,5	27	0 ÷ 25 ÷ 50 ≤ 0,35	18
233G	1,5	0,01	13	3	3	0,5	40	0 ÷ 25 ÷ 50 ≤ 0,35	18
232L	3	0,01	26	3	6	1	27	0 ÷ 50 ÷ 100 ≤ 0,20	36
232GL	3	0,01	26	3	6	1	40	0 ÷ 50 ÷ 100 ≤ 0,20	36
235G	0,6	0,002	13	1,5	2,5	0,1	40	0 ÷ 5 ÷ 10 ≤ 0,30	18



DIN 2270 and factory standard



Rotating dial



Contact points with tungsten carbide ball tips



Friction lever system to prevent overload



Supplied in a plastic storage case, including:
1 contact point, 2 mm dia.
1 rigid stem 8 mm dia. L = 15 mm, No. 01840107,
1 rigid stem 4 mm dia., L = 15 mm, No. 01840109



Serial number



Inspection report with a declaration of conformity

COMPAC 240 Reduced Range Models

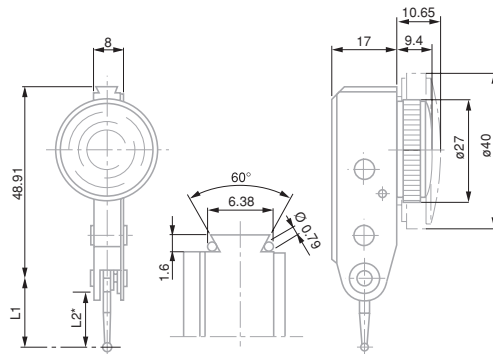

* L2 see table of inserts for COMPAC lever-type indicators

No	Total travel mm	mm	µm	µm	µm	Ø, mm	N	Insert L1, mm
242	0,8	0,01	13	3	3	27	0 ÷ 40 ÷ 0 ≤ 0,25	18
242G	0,8	0,01	13	3	3	40	0 ÷ 40 ÷ 0 ≤ 0,25	18
243L	0,5	0,01	13	3	3,5	27	0 ÷ 25 ÷ 0 ≤ 0,10	45
243GL	0,5	0,01	13	3	3,5	40	0 ÷ 25 ÷ 0 ≤ 0,10	45
245	0,2	0,002	4	1,5	2	27	0 ÷ 10 ÷ 0 ≤ 0,25	18
245G	0,2	0,002	4	1,5	2	40	0 ÷ 10 ÷ 0 ≤ 0,25	18



M1,6 coupling thread



The original inserts mounted on all indicators are fully interchangeable with inserts with different diameter tips as long as the insert has the same nominal length.

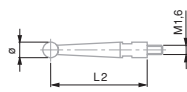

L1 = Axial length from ball to pivot



01866014

Measuring Inserts for COMPAC Models

No	Ball tip, mm	Ball tip material	L1, mm	L2, mm
01866014	0,8	Carbide	18	14,26
01866003	2	Carbide	18	14,26
01866021	3	Carbide	18	14,26
01866016	0,8	Carbide	36	32,26
01866004	2	Carbide	36	32,26
01866023	3	Carbide	36	32,26
01866015	0,8	Carbide	45	41,26
01866006	2	Carbide	45	41,26
01866022	3	Carbide	45	41,26
01866026	2	Ruby	18	14,26
01866027	2	Ruby	36	32,26

Accessories for COMPAC

Swivel Clamps



SPT

No	Stem	Clamping length
SPT	8 mm	25 mm
SPTA	1/4 in	1 in

Mounting Rods with Dovetail Grip

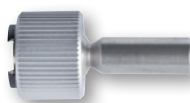

01850106

No		
01850106	Fixing shank swivelling through +/-30°	1/4 in
01850107	Rigid fixing shank	1/4 in
01840106	Fixing shank swivelling through +/-30°	8 mm
01840107	Rigid fixing shank Ø8mm	8 mm
01840108	Fixing shank swivelling through +/-30°	4 mm
01840109	Rigid fixing shank Ø4mm	4 mm





Clamp

No	=	
01860401	Dovetail clamp with tightening screw	mm Ø 5,6 / Ø 9,5



01860401

Mounting Rods

No	=	
01840404	Short swivel holder	mm Ø 8 x 25
01840405	Long swivel holder	Ø 8 x 90
01840406	Angular swivel holder	Ø 8 x 25 (Ø 8 for clamping bore)
01840501	Centering holder	Ø 8 x 25 (Ø 4 for clamping point)
01840407	Long sw. holder, fine adjust	Ø 8 x 125



01840501

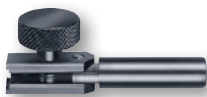

01840404



01840405

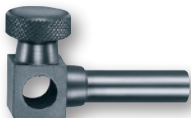

01840406



01840407

Fixing Shank

No	=	
01840104	Mounting rod	mm Ø 4
01840105	Mounting rod with dovetail clamp	Ø 8
01840202	Cylindrical fixing shank	Ø 8 x 80 (Ø 5,6 for the tenon)
01860008	Mounting rod	Ø 6

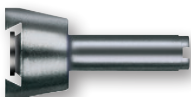

01840104

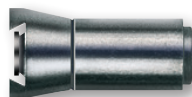

01840105



01840202

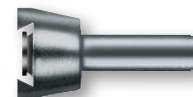

01860008

